

Article number: 20475B10B10MT

Description: E+G Two-way clamp mounting - GN 475-B10-B10-MT

Measures

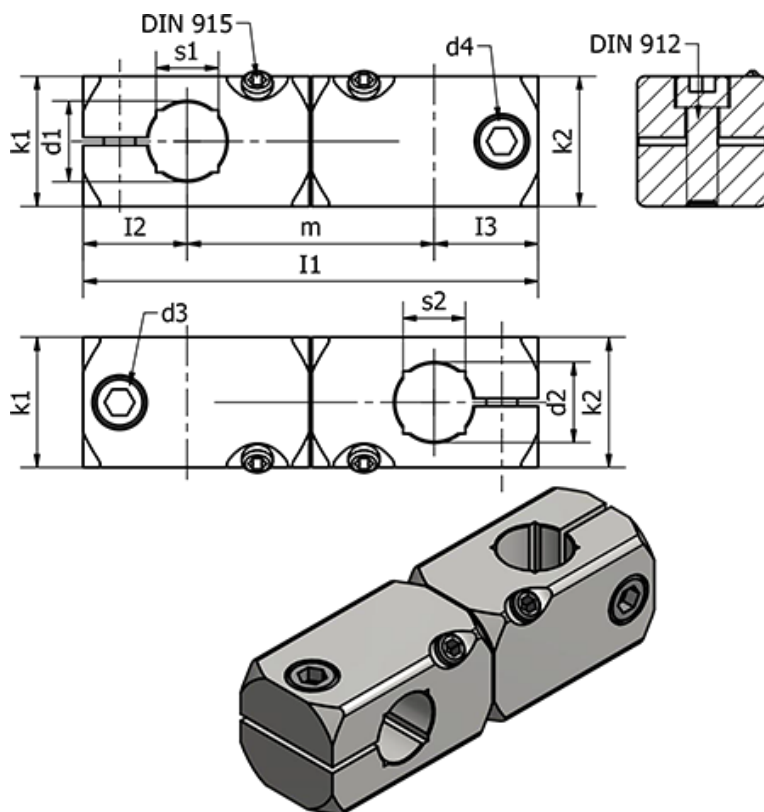

Clamping kit for d3 = GN 511-M5-20

Clamping kit for d4 = GN 511-M5-20

d1 = 10

d2 = 10

d3 = M5

d4 = M5

I1 = 63.5

I2 = 15.5

I3 = 15.5

k = 20

k2 = 20

m = 32.5

s1 = 8

s2 = 8

Weight (g) = 65